



Insight X2-VMS Appliance Manual 1.0

Thank You!

Thank you for choosing Nautic Alert® Insight X2 for VMS. Proudly engineered and assembled in the USA. We are confident your new purchase will provide an outstanding experience of edge-based *precision engineered technology*. Please take a few minutes to read through the instruction manual and familiarize yourself with the installation and setup process.

To ensure you have the latest instruction manual, please visit <https://nauticalert.com/support/instruction-manuals/>

Contents

VMS Appliance Overview.....	4
Technical Specifications	5
Product Labeling Requirements.....	5
Getting Started.....	6
Mounting, Wiring, and Antenna Options.....	6
Insight Mount Bracket and Wiring Description	7
Cable Wire Description and Powering On	8
Insight Dimensions and Flush Mounting.....	9
Device Activation	10
Insight Home Screen Overview.....	11
Alarm Indicator and Siren	11
Warning Dashboard	12
VMS Appliance Views.....	13
GPS View	13
VMS Messaging.....	14
Message Notifications.....	14
Address Book	15
VMS Settings	16
Declarations and Prelanding Reports	17
Nautic Alert Insight Manager.....	18
System Settings.....	18
Alert Notifications	18
Add New Wireless Sensor	18
Vessel Name.....	18
System Password	18
Daily Status Reporting.....	19
Receive Public Texts/Messaging	19
Received Message Beep.....	19
LCD Settings And Inactivity Timeout.....	19
Sensors.....	21
Event Log.....	21

Alert Recipients.....	22
Adding an Alert Contact.....	22
Firmware Updates.....	23
System Info	24
Mobile Access	25
Position Updates.....	26

VMS Appliance Overview

The Nautic Alert VMS Appliance is the most simple, lowest cost of ownership in a NOAA VMS solution. Unlike other systems that use PC-grade processor technology, the VMS Appliance is designed with a state-of-the-art low power architecture, enabling it to only consume 1.8W of power. This enables it to work with power constrained vessels, including solar-panel trickle chargers.

Additionally, all functions are integrated into the miniature multi-functional display, and do not require an external tablet. Messaging is included, and does not require complex mail forwarding configurations.

The VMS Appliance is featured on Nautic Alert's Insight X2 platform, but only offers the VMS application discussed herein. However, if additional non-VMS applications are wanted, the full Insight X2 can be used. With the full Insight X2 platform, the VMS Application as shown in this manual is available in addition to the following non-VMS applications (as discussed in the Insight X2 Manual):

- GEOS Monitored Search-And-Rescue with real-time two-way messaging
- Device to device and device to cell phone text messaging
- Indoor and outdoor advanced intrusion
- Multi-purpose sensors
- Multi-bank energy monitoring (DC and shore power)
- Bilge management
- Anchor Alarm

In either case, both options enable remote fleet management vessel tracking and push notifications, which are designed to keep your vessels in full compliance by providing maximum visibility into key system events.

Technical Specifications

Operating Voltage: 12V and 24V DC systems. Absolute min/max 10V-36V

Operating Current:

Screen full bright: 200mA @ 12V

Screen half bright: 150mA @ 12V

Screen off: 100mA @ 12V

Max with integrated siren active: 300mA @ 12V

Operating Temperature: -20 to 55C

Enclosure: Water resistant to CFR standards

Type-Approvals: NOAA VMS Type-Approvals for most US regions as indicated here:

<https://www.fisheries.noaa.gov/national/enforcement/noaa-fisheries-type-approved-vms-units>

Patents: US8531316 B2, USD687733 S1, US20140266793 A1

Product Labeling Requirements

Device Contains FCC ID: MCQ-S2CTH, MCQ-PS2CTH, and SBD9603X

This device complies with Part 15 of the FCC Rules. Operation is subject to the following two conditions:

(1) This device may not cause harmful interferences, and (2) this device must accept any interference received, including interference that may cause undesired operation.

The cellular and/or satellite antenna must be located at a distance greater than 20cm from the device and any persons under normal operating conditions to be compliant with FCC SAR limits.

Getting Started

- Mount and wire Insight to the DC system.
- Mount and wire the GPS and Cellular/Satellite antennas.
- Validate GPS signal strength and Iridium satellite signal strength with the GPS view and Iridium bars on the upper left of the Insight screen.
- Activate unit by going to www.nauticalalert.com, then following the “Activate” link on top of the page. **You will need the modem IMEI identifier as displayed in the [system settings](#) info tab.**
- Add your cell number to Insight’s alert [contacts](#) screen. This gives you access to Insight’s text message interface ,the MyInsights web portal, and the Nautic Alert [Mobile App](#).

Mounting, Wiring, and Antenna Options

Insight can be either bracket or flush mounted. Miniature high-performance Iridium and GPS antennas are provided with either 25’ or 50’ LMR cables to easily connect to the back of Insight. 25’ cables provide the most flexibility with a small diameter cable that is easy to run and bend. The 50’ Iridium cable is larger in diameter than the 25’ cable, and thus, the 25’ cable is recommended if the overall length between Insight and the antennas is less than 25’.



The antennas can be flush mounted, bracket mounted as shown above, or used with $\frac{3}{4}$ NPT adapters to attach to standard masts.

It is imperative that the antennas be located at a high elevation that avoids nearby obstructions, including solar panels. Maintain at least an 18 inch separation between the Iridium and GPS antennas when installing.

Connect the ends of the LMR cables to the correctly labeled antenna inputs on the back of Insight. If the antennas are connected backwards, this can easily be determined by inspecting the [GPS signal strength](#) and [Iridium signal strength](#) upon powering the unit. In this case, there will be no GPS or Iridium signal present.

Insight Mount Bracket and Wiring Description

Insight can be flush mounted by removing the front cover, and using the 4 underlying mount holes as shown below.

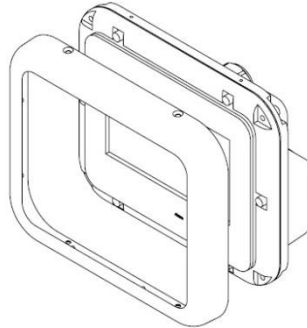

The front cover is held in place by machine screws that screw in from the top and bottom of the assembly. The 4 mounting holes behind the front cover used to flush mount are also used to attach the mounting bracket legs as shown below:



If using the mounting bracket, **attach the two side mounts to Insight prior to attaching to the mating bracket assembly.** 4 4-40 x $\frac{3}{4}$ machine screws hold the side brackets to Insight. **DO NOT OVERTIGHTEN.**

If using the bracket and mounting in a vertical configuration, the bracket mates together every 18 degrees, including 90 degrees, and use 2 M4 machine screws to fasten the side mounts to the main mount. At least 2 #4 screws are recommended for attaching the base of the main mount to the yacht mounting location. The base of the main mount can be rotated and locked in place.

When flush mounting, 4 #4 x 1 inch screws can be used to attach the Insight to the panel. **DO NOT OVERTIGHTEN.**

Cable Wire Description and Powering On

- Red - Power (+)
- Black - Ground (-)

Use with 12 and 24V DC systems.

Note: Your Insight will not startup if your DC voltage is insufficient and depleted. This feature allows your battery charger to bring your DC battery to a sufficient level before power is drawn, as well as prevent cycling of the Insight. At least 11 volts is required for your Insight to power on, otherwise, the Mute and Display buttons will blink red to indicate a low voltage is present. This feature is particularly useful in solar panel moored installations, where it's necessary to charge the boat's batteries to a sufficient level prior to putting an additional load on the batteries.

Always follow ABYC wiring standards and use an inline fuse or breaker appropriately rated.

Insight Dimensions and Flush Mounting

Insight dimensions are shown in inches below. Additional margin is needed for Insight cabling exit strain relief on the back side, in addition to the depth dimension shown below.

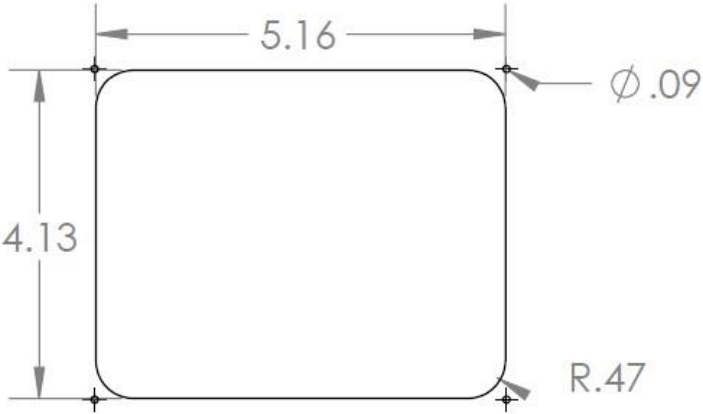
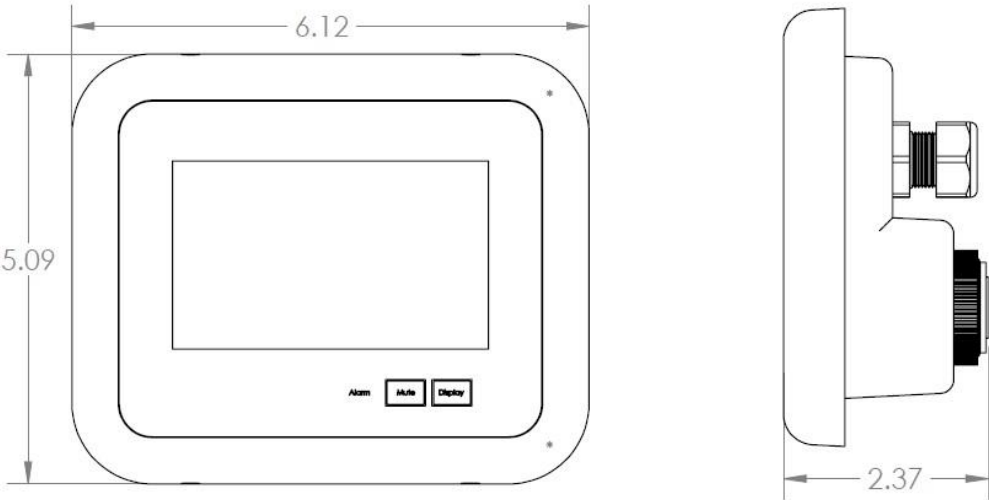

Recommended panel cutout dimensions for flush mounting

Device Activation

To activate communications, a Nautic Alert Reporting Service must be purchased. This allows for month-to-month billing through NearshoreNetworks, a Nautic Alert partner. To activate services, you must note the [modem MEID](#) and then go to:

<https://www.nearshorenetworks.com/menu/activate-services/nautic-alerts-activation>

Depending on the update interval of your region, the monthly costs will vary. This matrix of costs explains the plan differences:

<https://nauticalert.com/nautic-alert-platform/reporting-services/#VMS>

Once activation occurs, leave the device powered on and wait 24-48 hours. At that time, Nautic Alert will contact you or you can contact Nautic Alert at 1-800-385-1674 to acquire necessary details required by NOAA, which include the following

- Operating Region
- Name, address, and phone number of the owner
- Vessel name
- USCG documentation number

Once the device is activated with Iridium and NOAA, Nautic Alert will confirm the process is complete.

Insight Home Screen Overview

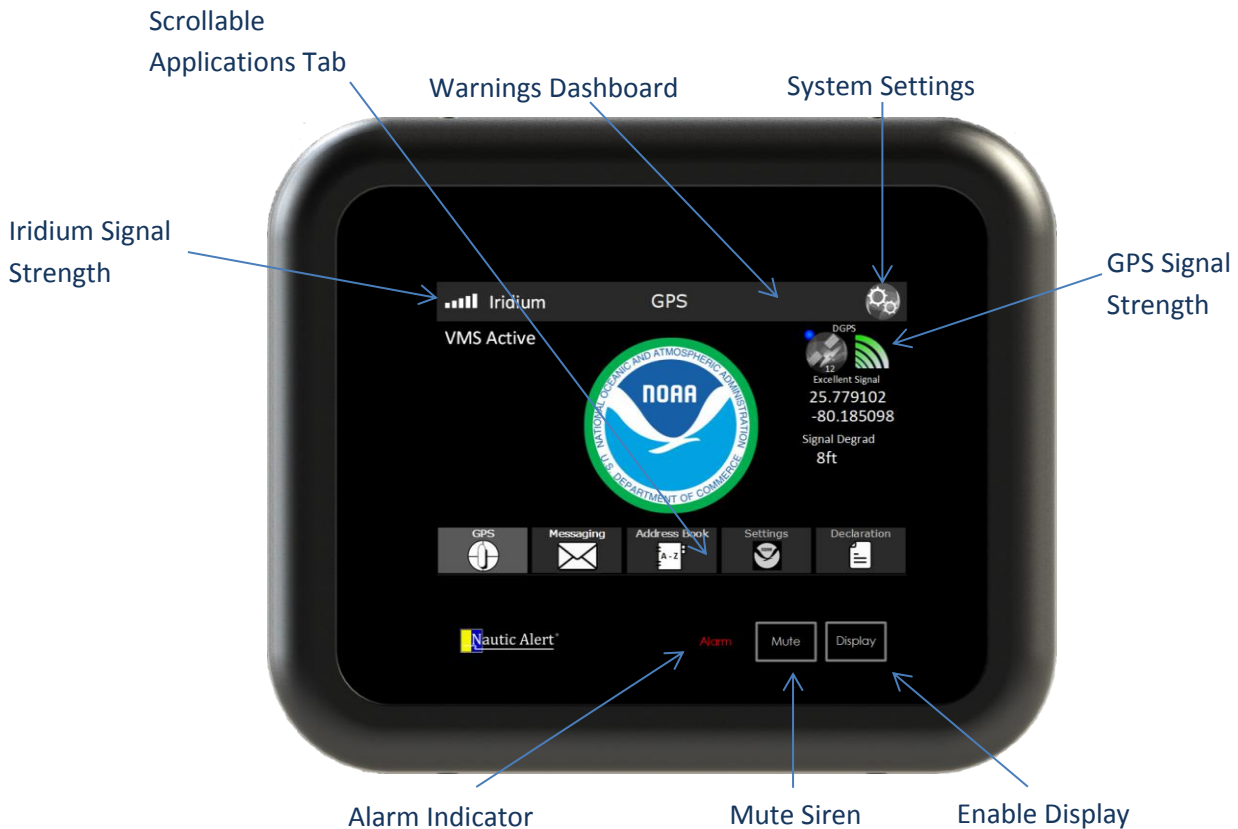

Home Navigation Tab

The Scrollable Home Navigation Tab is how you quickly navigate into the different VMS views, which include GPS, Messaging, Address Book, Settings, Declarations, and Prelandings. Declarations and Prelandings are only required to be used in select NOAA fishery regions.

Alarm Indicator and Siren

A loss of satellite communications or positioning will display applicable dashboard warning indicators, as well as illuminate the Alarm Indicator and activate the LCD display for a visual indicator of a problem that needs to be addressed.

[Mobile App](#) users will be notified of these events if [alerts](#) are enabled.

Warning Dashboard

The warnings dashboard may contain one or more red warning notifications as shown below:



GPS position unknown



Satellite connectivity lost



Integrated siren muted



No alert recipients programmed. Required for remote notifications



Message received

VMS Appliance Views

GPS View

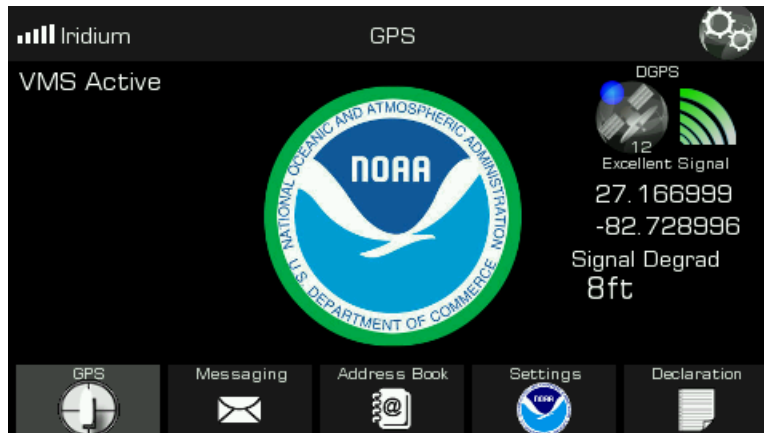

The GPS View displays the GPS position signal strength and expected accuracy, as indicated under the “Signal Degrad”. To be CFR compliant, the VMS unit must have a decent to excellent signal strength and maintain a Signal Degrad of less than 100 feet. Under normal circumstances, the Signal Degrad should be sub 20 feet.

If VMS transmissions are enabled, “VMS Active” will display on the upper left of the screen. This is not an indicator of if transmissions are succeeding, however. To validate successful transmissions, Insight’s reporting services must be [activated](#), satellite and GPS signals must be sufficient, and then the [mobile app](#) or web portal can be used to validate successful position reports are being sent.

The Nautic Alert Cloud contains a watchdog for VMS position events, and can notify authorized recipients in the event of position or communication disruptions. These events include GPS signal loss/restored events, as well as position report interruptions/restored events, which make it possible to be notified of unexpected issues before being notified by law enforcement. This feature ensures you have full visibility and confidence into the operation of your device and remain in compliance.

In order to receive these notifications, [alerts](#) must be enabled.

VMS Messaging

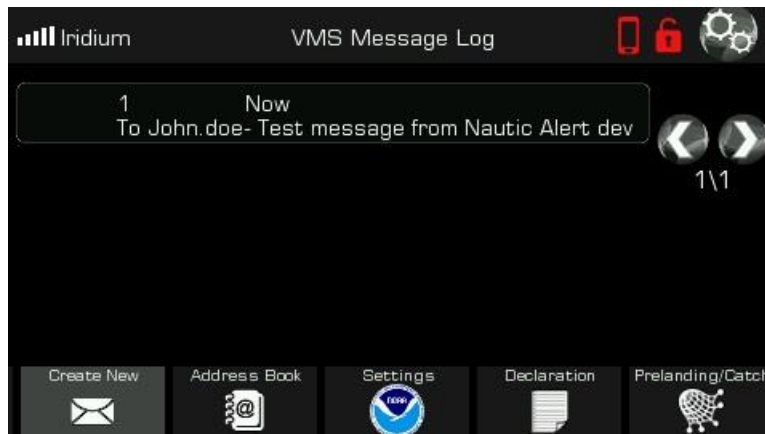

The VMS Message Log provides a quick view of all incoming and outgoing messages that have been sent and received.

VMS Messaging requires a valid noaa.gov or trackwell.com recipient to be able to send and receive messages to and from, and does not currently support general public email addresses.

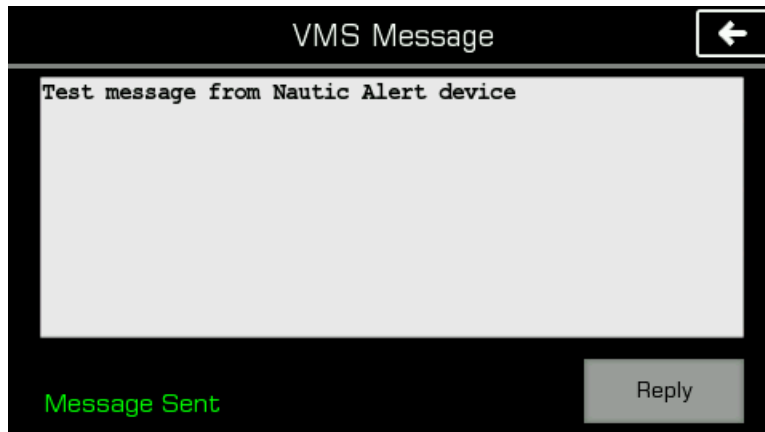

Confirmation of message delivery to the Nautic Alert Cloud can be displayed, as well as the contents of the message by pressing the message in the message log.

Message Notifications

Upon receiving a new message, the message received dashboard icon will display, and the LCD will automatically illuminate. The messaging navigation tab will also display a message icon.

If the [message beep setting](#) is enabled in the system settings, the Insight siren will beep once or continuous until the message is read.

Reading any unread messages clears the visual and audible notifications.

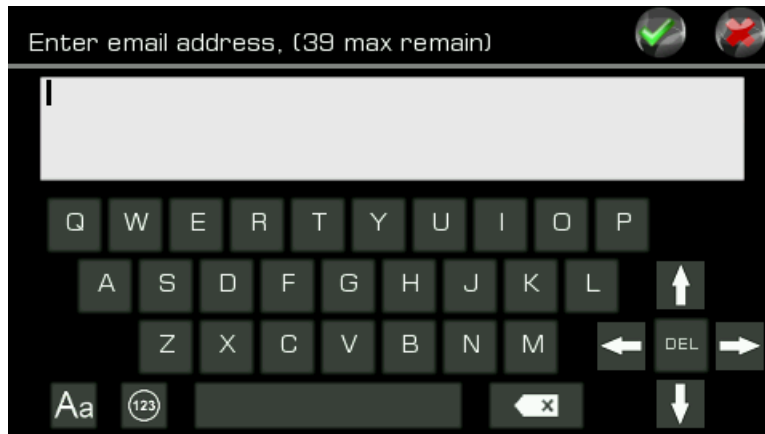

Creating new messages is done by tapping the “Create New” button once inside of the messages view.

Address Book

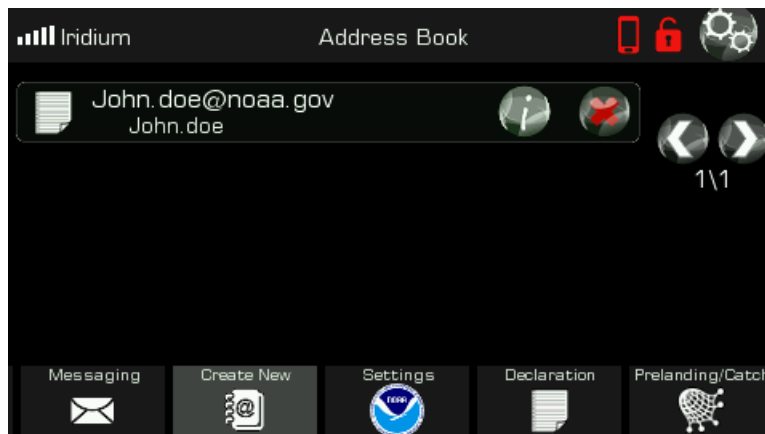

The address book automatically adds any messaging recipient or sender, for simple management.

A new message can be drafted by selecting an entry from the address book log.

VMS Settings

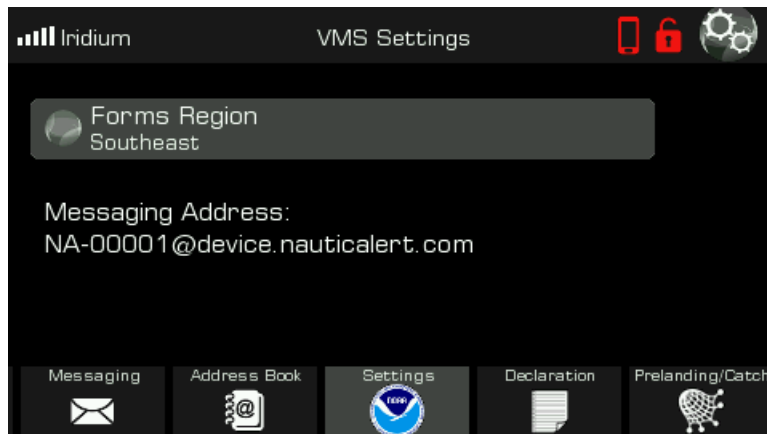

The VMS Settings contains the region of operation, which is used to display the correct forms for declarations and prelanding, if relevant.

The Messaging Address is the address that NOAA can use to message your device.

Declarations and Prelanding Reports

The Declarations and Prelandings list contains previously submitted reports. Tapping a previous entry will re-open the entry such that it can be re-submitted without having to re-create a new entry from scratch.

Alternatively, a new entry can be created from scratch by pressing the “Create New” button.



When an entry is submitted, a sending envelope will be present for each item in the list that is sending. If an error occurs, an error icon will be displayed, otherwise, the sending icon will disappear to show a successful delivery occurred.

Every entry will continue to retry sending unless the operation is aborted. If aborting an entry is desired, simply press the entry from the list then press the “Abort” button on the bottom of the screen.

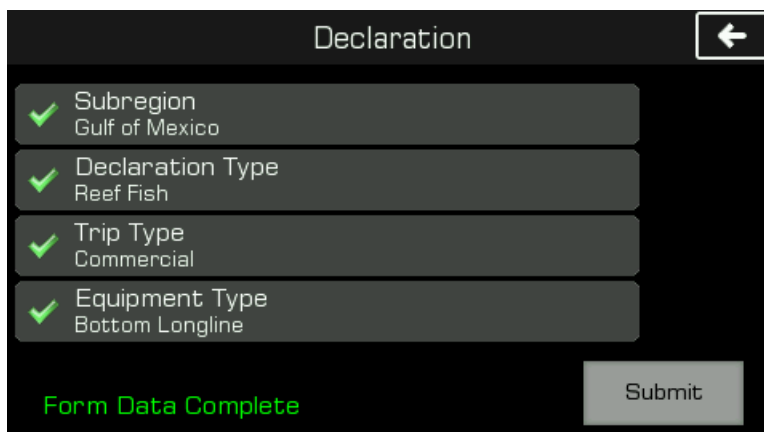
A screenshot of a "Declaration" form. The title "Declaration" is at the top with a back arrow icon. The form contains four rows, each with a green checkmark icon on the left and a text field on the right. The first row is "Subregion" with the value "Gulf of Mexico". The second row is "Declaration Type" with the value "Reef Fish". The third row is "Trip Type" with the value "Commercial". The fourth row is "Equipment Type" with the value "Bottom Longline". At the bottom left, the text "Form Data Complete" is displayed in green. At the bottom right, there is a "Submit" button.

When creating a new entry, all required entries must be entered before it is possible to submit the form. When ready, simply press the “Submit” button to send the declaration or prelanding message.

Nautic Alert Insight Manager

To access the manager, press the system settings button located on the home screen. Access to the Insight Manager requires system password entry if the system password is enabled.

System Settings

The following shows the first of three system settings screen:

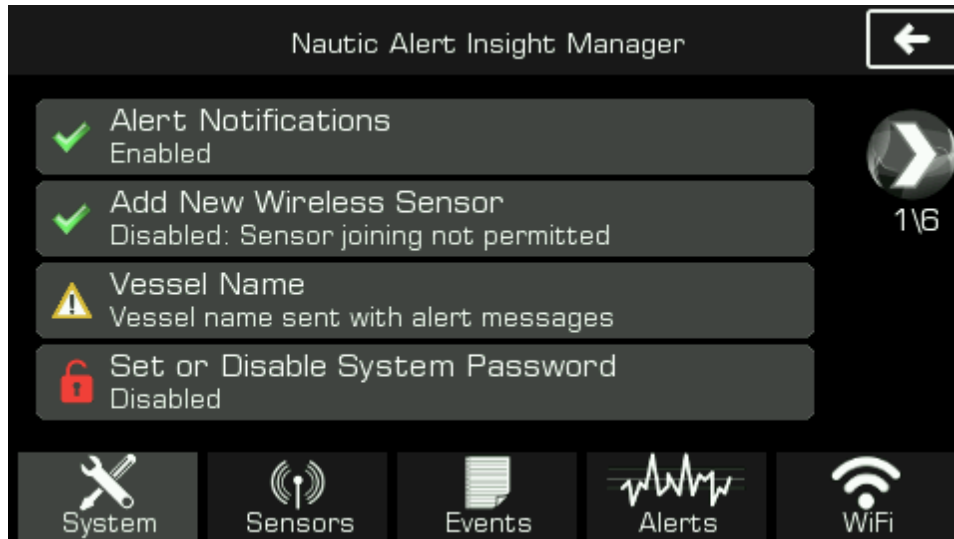

Alert Notifications

Enable or disable remote alert notifications. Requires at least one alert recipient. See [Alert Recipients](#) for more details.

For the VMS Appliance, alerts include VMS Watchdog events such as loss of communications or position.

Add New Wireless Sensor

Not applicable to VMS Appliance

Vessel Name

Name that distinguishes your yacht or Insight when you receive a text message. This is especially useful if you have more than one Insight, as it will tell you which Insight is generating the incoming message.

System Password

When set, access to system settings requires a password, and all application settings are inaccessible. A password can be recovered with the “password” sms command.

The system password is disabled by entering a blank password.

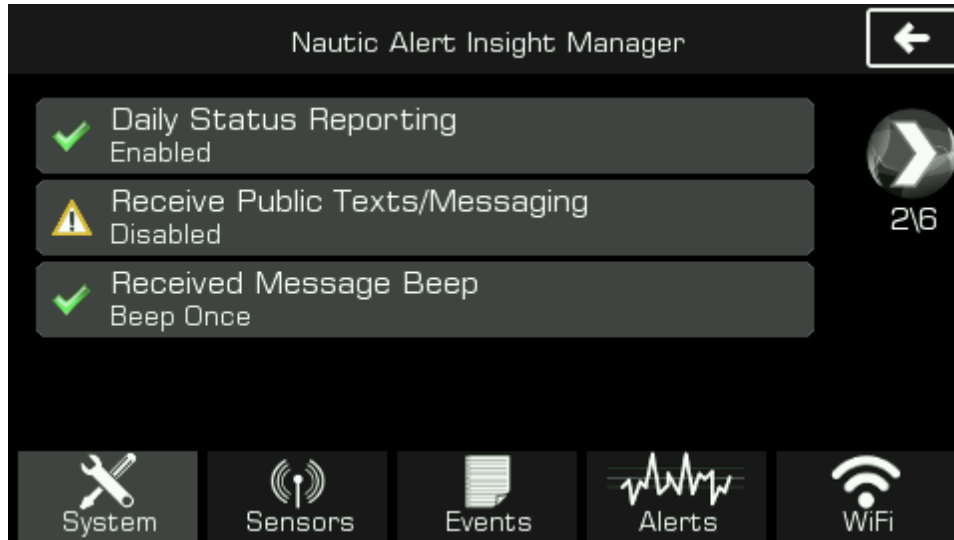

Daily Status Reporting

If Daily Status Reporting is enabled, users of the system will receive daily status messages to confirm that the device is active.

Receive Public Texts/Messaging

Not applicable to VMS Appliance

Received Message Beep

Toggles between disabled, Beep Once, or Beep Continuous. This is the setting for the audible alert setting that accompanies a received VMS message.

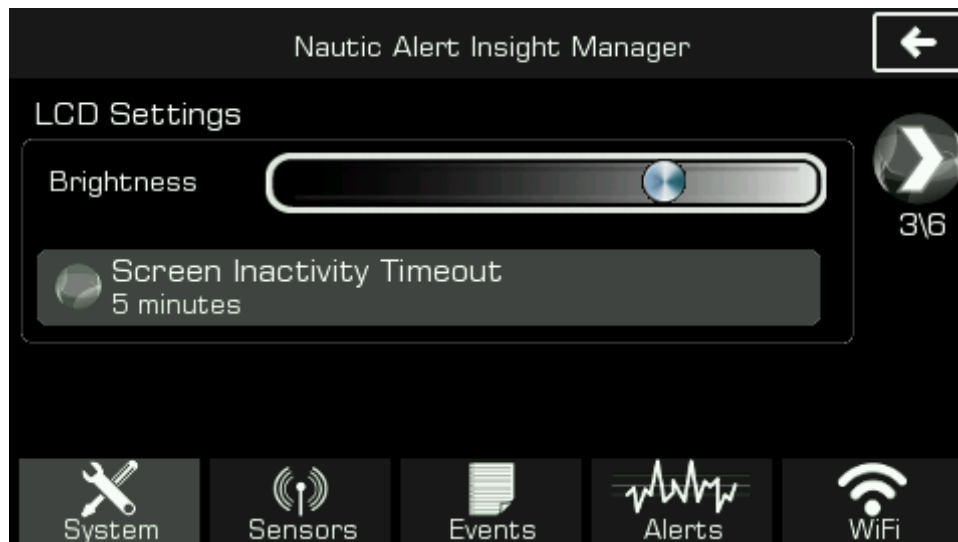

LCD Settings And Inactivity Timeout

Controls the brightness of the LCD and how long the LCD will stay on after a user touch event. The LCD will automatically turn on if an alert is present.

The remaining system settings are shown here for completeness only and are not applicable to the VMS Appliance.

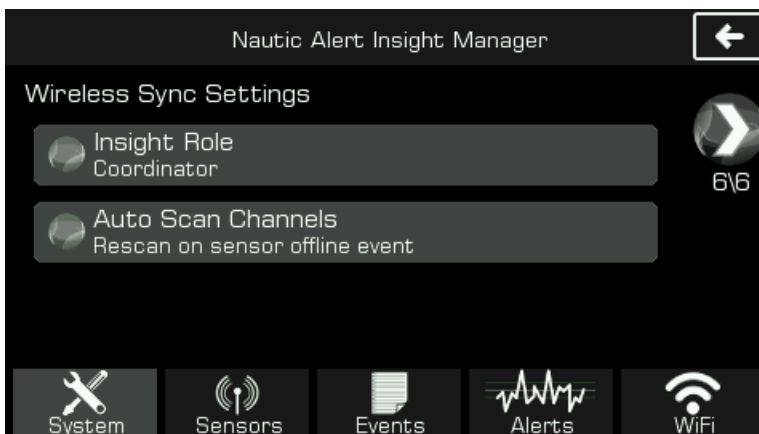
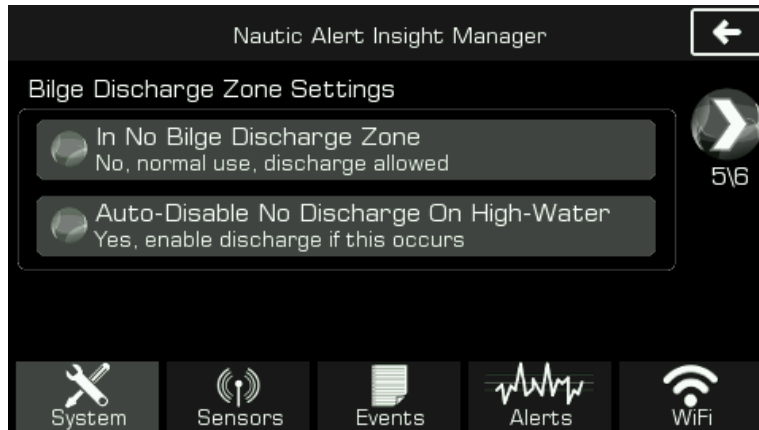
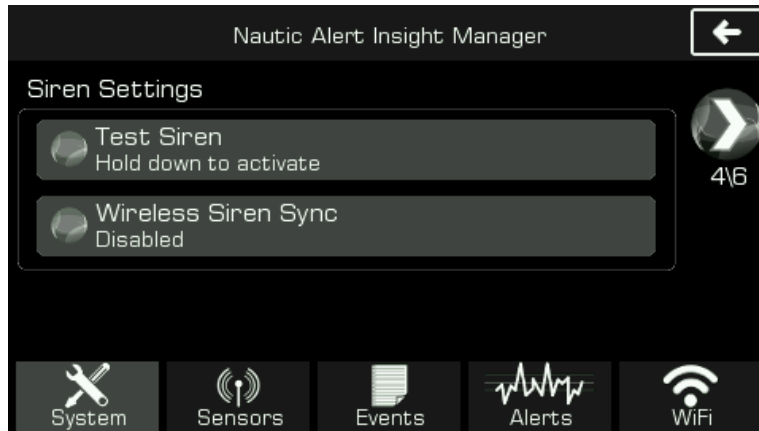

Sensors

Sensors are not applicable to the VMS Appliance

Event Log

The event log keeps track of all outgoing alert messages, as well as system generated events. The following is an example of the event log with multiple events present:

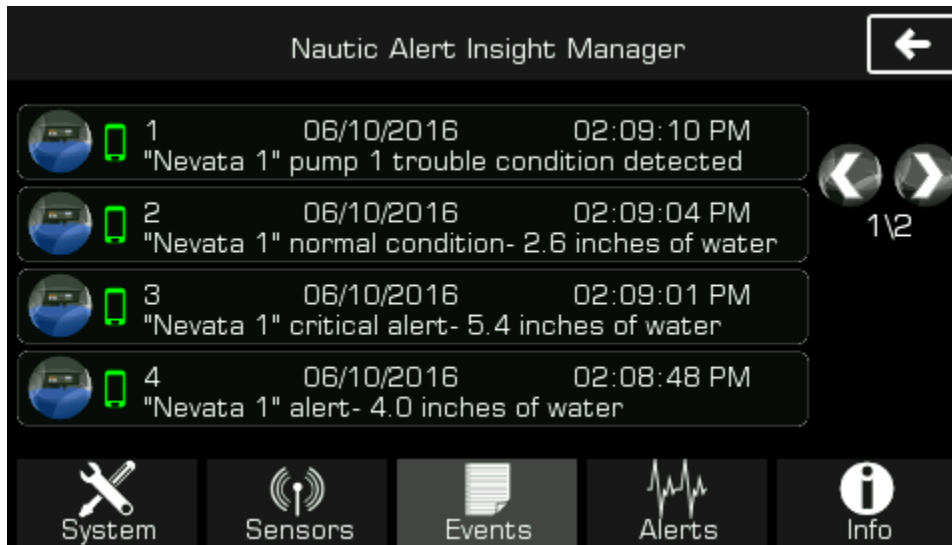

Pressing an event will show additional details about the event, in particular, if the event was sent or why it was not sent, and any issues that were observed in sending the event.

The event log will hold up to about 50 event messages. Once the event log is full, a new message will cause the oldest message to be discarded.

Alert Recipients

Up to three alert recipients can be added. The first entry added is considered the system administrator. Additionally, the admin can use the mobile app or web portal to add additional users.

Adding an Alert Contact

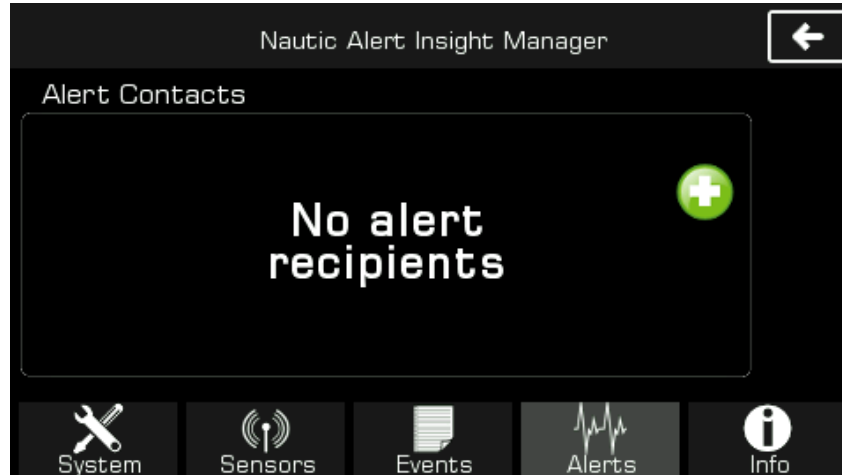

To add a new alert contact, simply press the “+” button shown here. Next, you will be prompted for the cell phone number, and a verification code will be sent to that number.

In order to add an alert recipient, the device must have an active Iridium subscription.

Firmware Updates

From time to time, firmware updates may be required. In order to update the device firmware, it is necessary to connect Insight to the internet via the built-in WiFi, then use the Firmware update application to automatically detect and apply newer firmware updates.

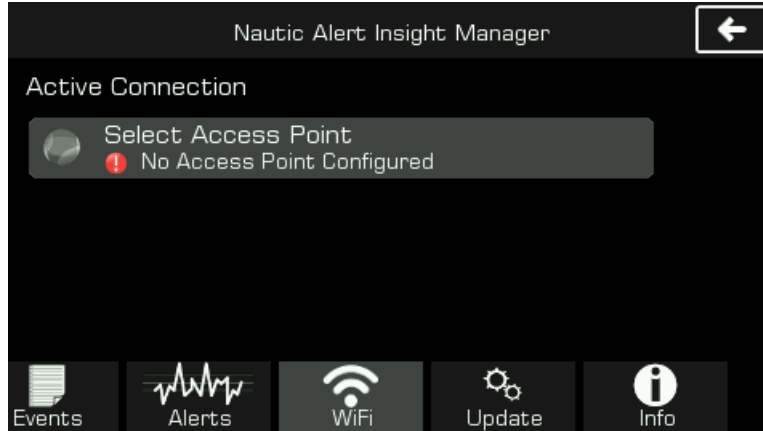

Enter the WiFi application, then select “Select Access Point” to display available SSIDs and connect.

The easiest way to facilitate connecting to the internet may be to enable your phone’s hot spot then connect Insight to your phone. The firmware image is typically less than 3MB, which is extremely small and will not have any noticeable impact to cellular data usage.

Once connected, press the “Update” tab to enter the firmware update application as shown here:

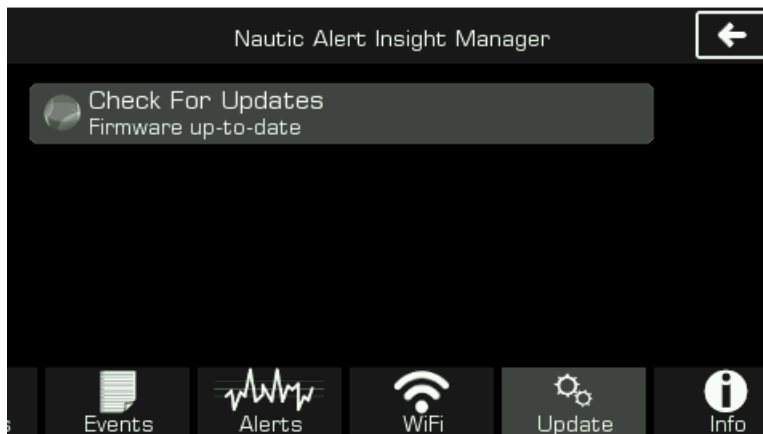

Pressing on “Check For Updates” will check if any updates are available. If there are, it will display info and allow you to download the update.

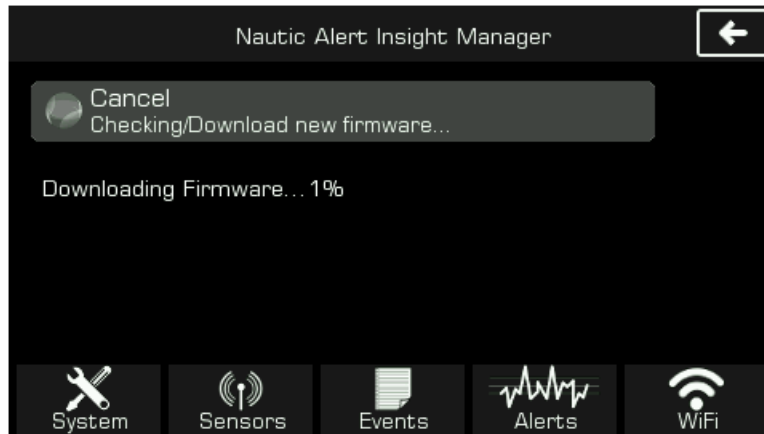

The download process typically takes several minutes, and once complete, you will be prompted to install the update. Once the update is installed, Insight will automatically reboot. Do not interrupt this process by removing system power.

System Info

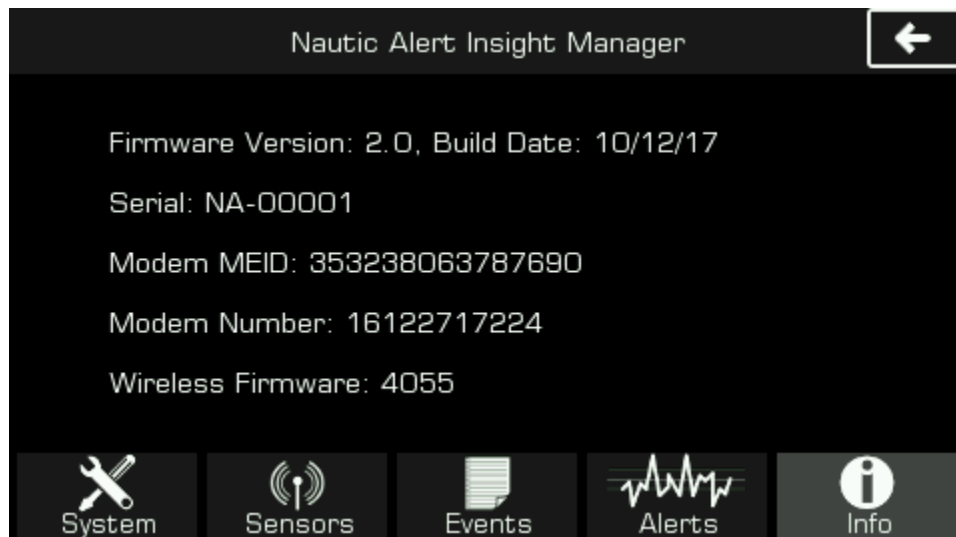

The system info contains the firmware version of your Insight, and mobile cell number assigned to the Insight, as well as the modem MEID. The MEID is the number needed to activate Insight via Nautic Alert’s activation portal.

Mobile Access

The Nautic Alert Mobile App or MyInsights web portal can be used access vessel location information.

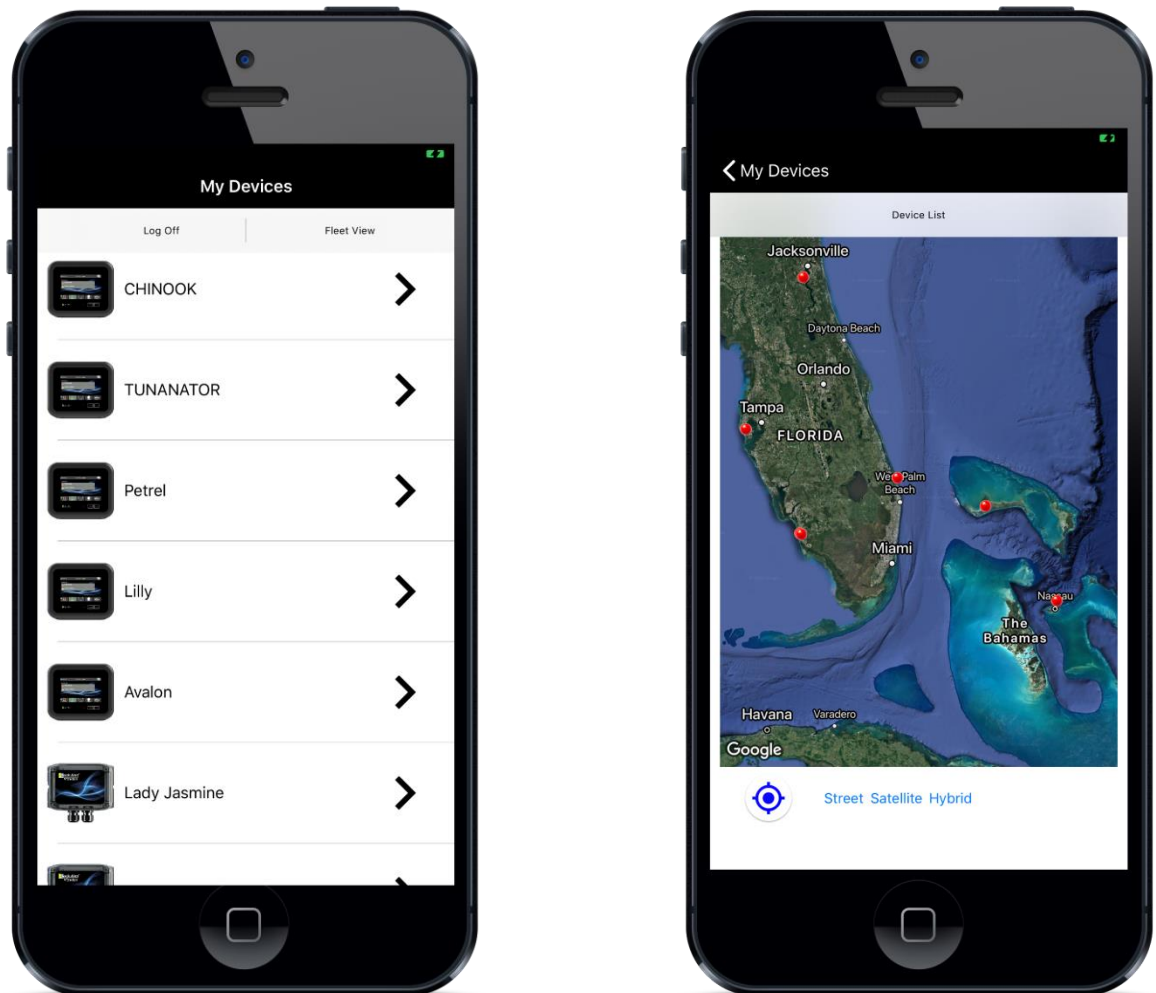

All devices that contain your cell phone are automatically linked to your Nautic Alert account. Using the mobile app, all devices can easily be viewed simultaneously in the Fleet View.

VMS position loss and restored events, as well as communications lost and restored events, are pushed as push notifications to app users, if [alerts](#) are enabled.

Position Updates

From the location view, the last position update timestamp can easily be determined.

